

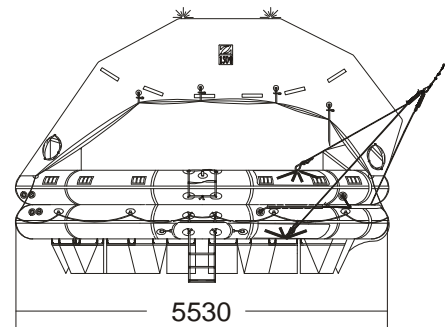

MARINE EVACUATION SYSTEM (MES) 150 MAN THROW OVER BOARD SELF RIGHTING LIFERAFT ASSOCIATED WITH SMALL INFLATABLE SLIDE (SIS)

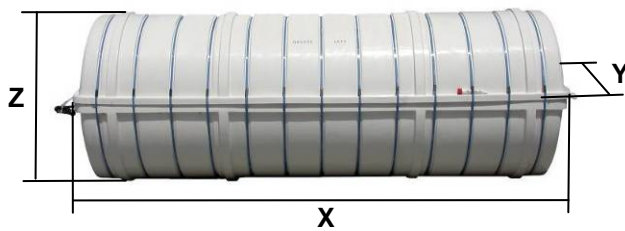
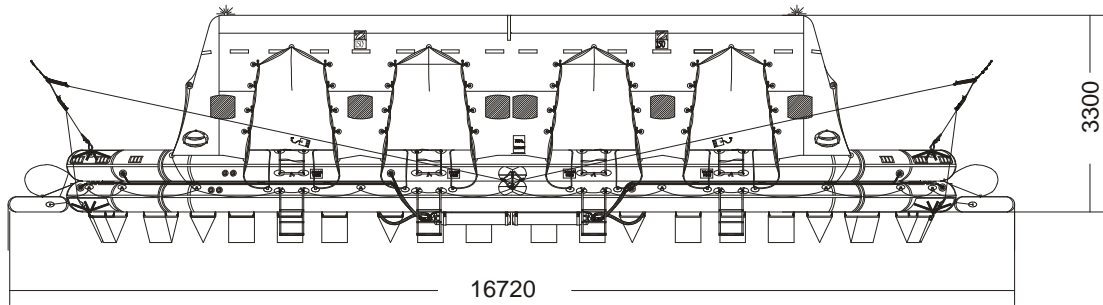
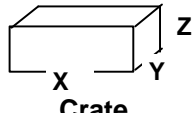

TECHNICAL INFORMATION (SIS information on page 2)

150 MAN MES SIS	A PACK			B PACK		
Container	N24			N23		
Dimensions	X: 3340 mm	Y: 1150 mm	Z: 1135 mm	X: 3340 mm	Y: 1050 mm	Z: 1035 mm
	X: 10' 11,5"	Y: 3' 9,28"	Z: 3' 8,69"	X: 10' 11,5"	Y: 3' 5,34"	Z: 3' 4,75"
Liferaft Net Weight	1300 kg / 2866 pounds			880 kg / 1941 pounds		
Max. height stowage	25 m / 83'			25 m / 83'		
Painter line length	35 m / 115'					
Inflation Cylinder	6 x 35 liter					
 Crate	X: 3490 mm	Y: 1290 mm	Z: 1280 mm	X: 3490 mm	Y: 1190 mm	Z: 1180 mm
	X: 11' 5,41"	Y: 4' 2,79"	Z: 4' 2,4"	X: 11' 5,41"	Y: 3' 10,86"	Z: 3' 10,46"
	1400 kg / 3087 pounds			970 kg / 2139 pounds		
	5,763 m3 / 203,49 cubic foot			4,901 m3 / 173,05 cubic foot		
Towing force	2 knots			3 knots		
Without sea anchor	240 daN			470 daN		
With sea anchor	270 daN			510 daN		

Dimensions and weight +/- 5% Zodiac reserves the right to change specification without notice.
For installation, add minimum +10mm for clearance to dimensions of the container.



ZODIAC

MARINE SOLAS

SIS	1,70 m			2,20 m		
Valise						
Dimensions	X:670mm	Y:300mm	Z:260mm	X:720mm	Y:425mm	Z:295mm
	X:2' 2,38"	Y:1' 11,82"	Z:10,24"	X:2' 4,35"	Y:1' 4,74"	Z:11,62"
Liferaft Net Weight	15 kg / 34 pounds			19 kg / 42 pounds		
Max. height stowage	1,70 m			2,20 m		
Painter line length	1,50 m			1,50 m		
Inflation Cylinder	1 x 2,83 litres			1 x 4 litres		

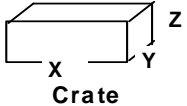
 Crate	X:830mm	Y:540mm	Z:330mm	X:830mm	Y:540mm	Z:330mm
	X:2' 8,68"	Y:1' 9,26"	Z:1' 1"	X:2' 8,68"	Y:1' 9,26"	Z:1' 1"
	17,6 kg / 39 pounds			21,6 kg / 48 pounds		
	0,148 m ³ / 5,23 cubic foot			0,148 m ³ / 5,23 cubic foot		

SIS	2,70 m			3,20 m		
Valise						
Dimensions	X:720mm	Y:450mm	Z:295mm	X:800mm	Y:450mm	Z:295mm
	X:2' 4,35"	Y:1' 5,72"	Z:11,62"	X:2' 7,5"	Y:1' 5,72"	Z:11,62"
Liferaft Net Weight	27 kg / 60 pounds			28,5 kg / 63 pounds		
Max. height stowage	2,70 m			3,20 m		
Painter line length	1,50 m			1,50 m		
Inflation Cylinder	1 x 6 litres			1 x 6,7 litres		

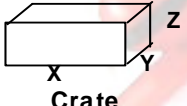
 Crate	X:830mm	Y:540mm	Z:330mm	X:830mm	Y:540mm	Z:330mm
	X:2' 8,68"	Y:1' 9,26"	Z:1' 1"	X:2' 8,68"	Y:1' 9,26"	Z:1' 1"
	29,6 kg / 66 pounds			31,1 kg / 69 pounds		
	0,148 m ³ / 5,23 cubic foot			0,148 m ³ / 5,23 cubic foot		

SIS	3,80 M		
Valise			
Dimensions	X: 820 mm	Y: 450 mm	Z: 350 mm
	X: 2' 8,29"	Y: 1' 5,72"	Z: 1' 1,78"
Liferaft Net Weight	37 kg / 82 pounds		
Max. height stowage	3,8 m / 13'		
Painter line length	1,5 m / 5'		
Inflation Cylinder	1 x 10 liter		

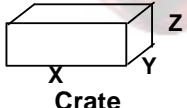
 Crate	X: 920 mm	Y: 560 mm	Z: 370 mm
	X: 3' 0,23"	Y: 1' 10,05"	Z: 1' 2,57"
	40 kg / 89 pounds		
	0,191 m ³ / 6,74 cubic foot		

Approvals: **EC (MED)**

150 TO SR MES SIS cont rond Zodiac 05032009 KLT Issue : 1 Date: 05/03/2009

Dimensions and weight +/- 5% Zodiac reserves the right to change specification without notice.
For installation, add minimum +10mm for clearance to dimensions of the container.